

Product Catalog

black widow

EXHAUST



The King of Sound.™



BLACK WIDOW EXHAUST

Black Widow Exhaust's™ design was developed with the intention of creating that classic '60's circle track stock car 180° header sound. That unique and classic sound was achieved, but ultimately, we designed a universal muffler that can be used on almost any vehicle with 4 wheels*.

With an ideal balance between exhaust velocity and exhaust volume using acoustic sound wave deflection, our internal design achieves distinctive sound characteristics unlike any other performance muffler on the market.

OUR DESIGN

Black Widow's patent pending high-velocity hourglass design compresses exhaust going in and forces exhaust going out – creating an ideal balance between exhaust velocity and exhaust volume, thus reducing opportunity for drone and creating that aggressive Black Widow Exhaust sound.

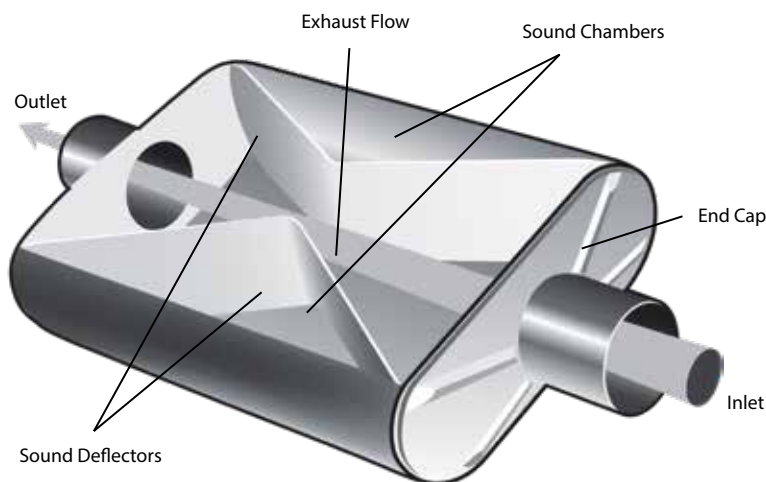

Note: The diagram above is for illustration purposes to show airflow.
All Black Widow Exhaust mufflers are bi-directional.

THE BENEFITS

- Crisp, clean and aggressive sound
- Straight through design allows for maximum horsepower
- Universal 2.5", 3" and 3.5"* and 4"* sizes for almost any application
- Constructed out of quality stainless steel
- Consistent sound throughout the life of the muffler
- Backed by a Limited Lifetime Warranty (See warranty details at www.blackwidowexhaust.com/technical/warranty)
- All Black Widow Exhaust mufflers are bi-directional

* 3.5" and 4" available for Race Venom, Angry Housewife, Neighborhater and Widowmaker mufflers only.

The King of Sound.™

Black Widow Exhausts' mufflers were designed without the droning characteristics that packed and chambered mufflers produce. Although multiple factors contribute to the creation of drone such as placement of muffler, size of piping, length of tailpipe, etc., we stand behind our design that drone is less likely to be created with the use of our muffler than with than with our competitors' products. Along with that, our mufflers produce, what we consider to be, "the ideal sound for your vehicle*!"

* Sound is subjective. We do not guarantee that your vehicle will sound exactly as expected.

© 2014 Black Widow Performance, Inc. Black Widow Tuned Performance Exhaust and Black Widow Exhaust are registered trademarks of Black Widow Performance, Inc. All Rights Reserved.

Not intended for diesel applications after 2007.

Black Widow Swag



Shirts

Hoodies

Cups

Koozies

Hats

Beanies

Vinyl Logo Stickers

Round Stickers

Vinyl Shop Banners

License Plate Frames

Backpacks

Photo courtesy of Spider John Jacobs

Now Available...

The Big D



Body Size: 14 3/4" x 7 1/2"
Overall Length: 21 3/4"
Inlet/Outlet Length: 2" (each side)
Material: 409 Stainless Steel
Bi-Directional

Size **DOES** matter when we're talking about mufflers. Black Widow's Big D muffler is in a class of it's own at almost 22" long and width of 7 1/2". If you're looking for that aggressive Black Widow sound but require a bigger footprint, the Big D is here!

Part #'s BWBIGD-35 (3.5") / BWBIGD-4 (4") / BWBIGD-5 (5")

Widowmaker

Our most aggressive muffler yet, the Widowmaker is simply for those who demand attention. An alternative to a straight pipe setup, Black Widow Widowmakers manage sound and reduce the opportunity for drone.

Part #'s

BW0013-2 2.5" (center/center)
BW0013-3 3" (center/center)
BW0013-35 3.5" (center/center)
BW0013-4 4" (center/center)

Available Configuration

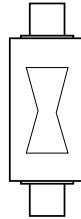

Part #'s

BW0012-25 2.5" (center/center)
BW0012-30 3" (center/center)
BW0012-35 3.5" (center/center)
BW0012-40 4" (center/center)

Widowmaker 10"

Body Size: 10" x 5"

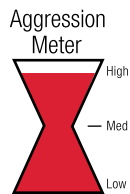

Widowmaker 6"

(AKA Neighborhater)

Body Size: 6" x 5"

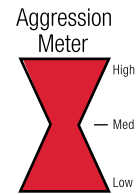

We Are The



Customer.

At Black Widow Exhaust we make quality mufflers and exhaust-related products that we would want for our vehicles. If you like to hear the power of your ride and want your exhaust system to allow as much horsepower as possible - then our products are for you.

— The Black Widow Team



Race Venom

The Race Venom, designed primarily for restricted space, has become widely popular for anyone wanting a more aggressive tone than our 250-series, yet still providing the same sound characteristics as our 250 and 300-series mufflers.

Part #'s

Race Venom

- BW009-C 2.5" (center/center)
- BW009-P 2.5" (offset/center)
- BW0010-C 3" (center/center)
- BW0010-P 3" (offset/center)
- BW0011-C 3.5" (center/center)
- BW0011-P 3.5" (offset/center)
- BWSDR-32 3"/2.5" (single/dual)
- BWSDR-33 3"/3" (single/dual)
- BWDDR-22 2.5"/2.5" (dual/dual)
- BWDDR-33 3"/3" (dual/dual)
- BWOOR2-22 2.5"/2.5" (offset/offset)
- BWOOR2-33 3"/3" (offset/offset)

Angry Housewife

- BWAHW25-C 2.5" (center/center)
- BWAHW25-P 2.5" (center/offset)
- BWAHW30-C 3" (center/center)
- BWAHW30-P 3" (center/offset)
- BWAHW-32 3"/2.5" (single/dual)
- BWAHW-33 3"/3" (single/dual)
- BWAHWDD-22 2.5"/2.5" (dual/dual)
- BWAHWDD-33 3"/3" (dual/dual)

Available Configurations

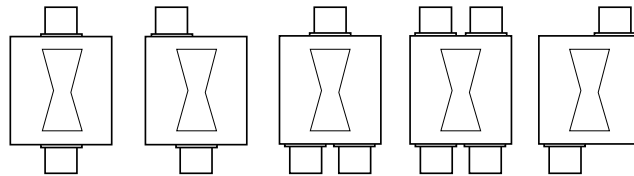

Race Venom

Body Size: 9" x 9" x 4"

Angry Housewife

Body Size: 6" x 9" x 4"

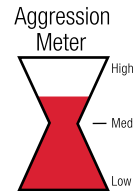
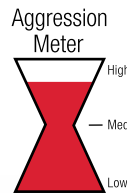

Venom

250-series

The Venom 250-series is the perfect choice for those looking for a more aggressive sound and want their ride to stand out from the rest. This model set the benchmark for the 300-series, Race Venom and Widowmaker mufflers.

Part #'s

BW001-C 2.5" (center/center)

BW001-P 2.5" (offset/center)

BW002-C 3" (center/center)

BW002-P 3" (offset/center)

BWSDV-32 3"/2.5" (single/dual)

BWSDV-33 3"/3" (single/dual)

BWDDV-22 2.5"/2.5" (dual/dual)

BWDDV-33 3"/3" (dual/dual)

BWOOV2-22 2.5"/2.5" (offset/offset)

BWOOV2-33 3"/3" (offset/offset)

Available Configurations

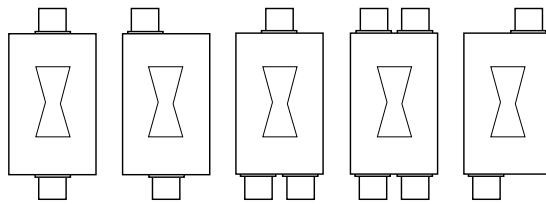

Body Size: 14" x 9" x 4"

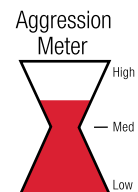

Venom 300-series

If you're looking for a more aggressive sound but don't want to wake up the neighbors, the Venom 300-series will give you just that – and at the same time, give your vehicle that Black Widow Exhaust tone – while still turning heads.

Classic Series

Part #'s

BW005-C 2.5" (center/center)

BW005-P 2.5" (offset/center)

BW004-C 3" (center/center)

BW004-P 3" (offset/center)

BW00V3-22 2.5" (offset/offset)

BW00V3-33 3" (offset/offset)

BWSDV3-32 3" (single/dual)

BWSDV3-33 3" (single/dual)

Available Configurations

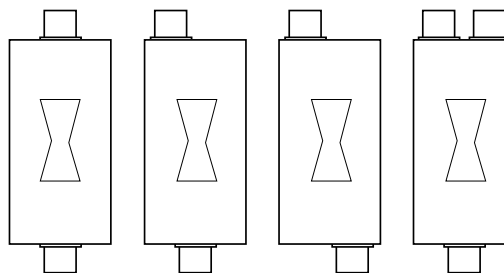

Body Size: 18" x 9" x 4"

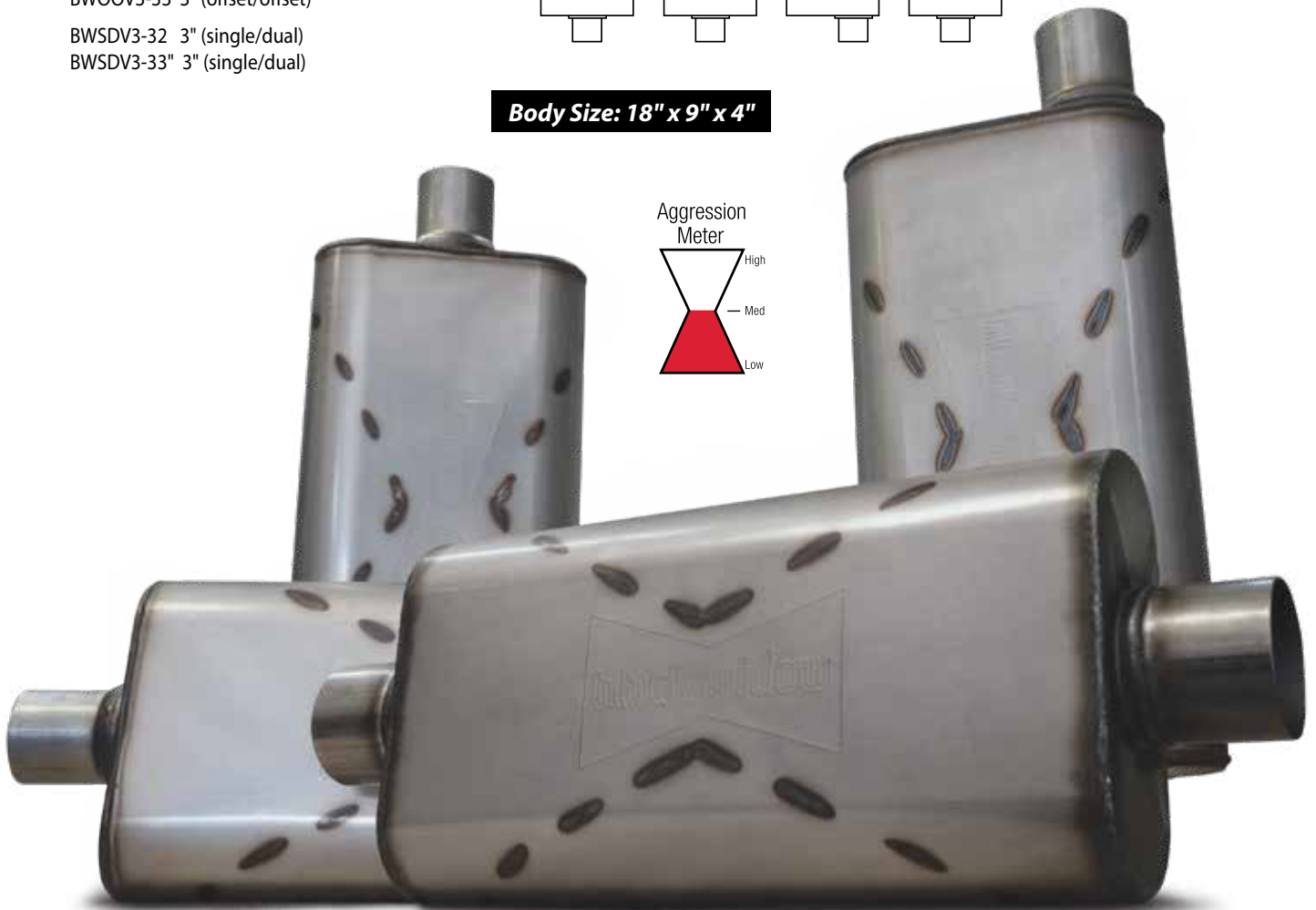
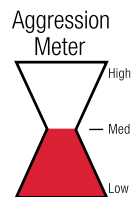

X and Y Pipes

Black Widow X pipes are quality constructed out of stainless steel and maximized to balance and smooth out dual exhaust flow. Available in 2.5" and 3".

Part #'s

BW0014-2 (2.5")
BW0014-3 (3")

Stainless Steel/Mandrel Bent



Turning a single exhaust into dual tailpipes or replacing an old Y pipe is no problem with our high quality stainless steel Y pipe. Available in multiple sizes to accommodate an existing setup.

Part #'s

BW0015-22 (2.5" single/2.5" dual)
BW0015-32 (3" single/2.5" dual)
BW0015-33 (3" single/3" dual)

Stainless Steel/Mandrel Bent



black widow[®]
E X H A U S T

11664 COLEY RIVER CIRCLE
FOUNTAIN VALLEY, CA 92708

MAIN: (949) 228-9715
FAX: (949) 333-0906

INFO@BLACKWIDOWEXHAUST.COM